

TYPICAL SWITCH ORDERING EXAMPLE

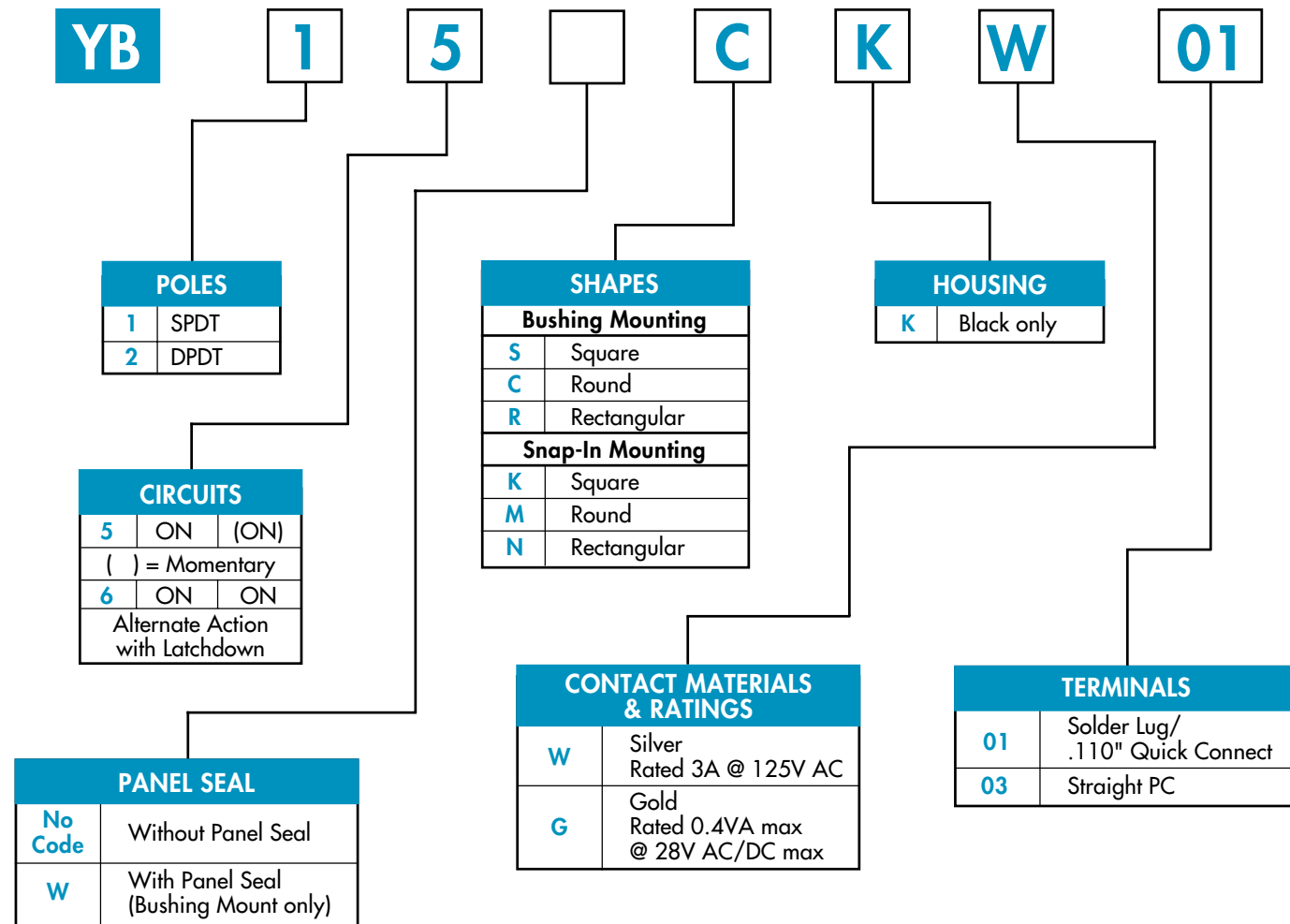

IMPORTANT:

Switches are supplied without UL & CSA marking unless specified. Specific models & ratings noted on General Specifications page.

DESCRIPTION FOR TYPICAL ORDERING EXAMPLE
YB15CKW01-6F-JB



LAMPS

Incandescent Lamp	
05	5-volt
12	12-volt
28	28-volt
00	No Lamp

LED for Spot Illuminated Cap

LED Colors		Forward Voltage	
1C	Red	02	2-volt (no resistor)
1D	Amber	05	5-volt
1F	Green	12	12-volt
1CF	Red/Green	24	24-volt

Bright LED

5C	Red
5D	Amber
5F	Green

Super Bright LED

6B	White
6F	Green
6G	Blue

Bicolor LED for Full Face Illuminated

LED Colors		Forward Voltage	
2CF	Red/Green	02	2-volt (no resistor)
		05	5-volt
		12	12-volt
		24	24-volt

CAP TYPES & COLORS

Solid Cap: Lens/Insert Colors	
BB	White/White
CB	Red/White
EB	Yellow/White
FB	Green/White
GB	Blue/White

Spot Illuminated Cap Lens/Insert Colors

JA	Clear/Black
JB	Clear/White
JC	Clear/Red
JE	Clear/Yellow
JF	Clear/Green

LED Cap: Lens/Insert Colors

JB	Clear/White
----	-------------

LED Cap: Lens/Insert Colors

JB	Clear/White
----	-------------

GENERAL SPECIFICATIONS

Electrical Capacity (Resistive Load)

Power Level: 3A @ 125V AC or 3A @ 250V AC or 3 A @ 30V DC
Logic Level: 0.4VA maximum @ 28V AC/DC maximum
 Note: See Supplement Index (page Z1) to find explanation of operating range.

Other Ratings

Contact Resistance: 50 milliohms maximum for silver; 100 milliohms maximum for gold
Insulation Resistance: 200 megohms minimum @ 500V DC
Dielectric Strength: 1,000V AC minimum between contacts; 1,500V AC minimum between contacts & case
Mechanical Life: 1,000,000 operations minimum for momentary action
 200,000 operations minimum for alternate action
Electrical Life: 100,000 operations minimum
Nominal Operating Force: Single pole: 150 grams for nonsealed; 170 grams for sealed
 Double pole: 280 grams for nonsealed; 300 grams for sealed
Contact Timing: Nonshorting (break-before-make)
Travel: 1.5mm (.059") pretravel; 1.5mm (.059") overtravel; 3mm (.118") total travel

Materials & Finishes

Housing/Bezel: Glass fiber reinforced polyamide
Snap-in Frame: Stainless steel
Base: Diallyl phthalate resin
Movable Contactor: Phosphor bronze with silver plating or gold plating over nickel
Movable Contacts: Silver alloy with silver plating or brass with gold plating over nickel
Stationary Contacts: Silver alloy or copper with gold plating over nickel
Power Terminals: Phosphor bronze with tin-lead plating
Lamp Terminals: Phosphor bronze with tin-lead plating

Environmental Data

Operating Temp Range: -25°C through +50°C (-13°F through +122°F) for Illuminated
 -25°C through +70°C (-13°F through +158°F) for Nonilluminated
Humidity: 90 ~ 95% humidity for 96 hours @ 40°C (104°F)
Vibration: 10 ~ 55Hz with peak-to-peak amplitude of 1.5mm traversing the frequency range
 & returning in 1 minute; 3 right angled directions for 2 hours
Shock: 50g acceleration (tested in 6 right angled directions, with 5 shocks in each direction)
Sealing: IP65 of IEC529 standard for panel seal models

Installation

Mounting Torque: 8.16 kg/cm (7.08 lb/in) downward force on actuator
Soldering Time & Temperature: 3 seconds @ 350°C
Process Seal: Not available

Standards & Certifications

Flammability Standards: UL94V-0 housing & base
UL Recognized: All solder lug models recognized at 3A @ 125/250V AC or
 0.4VA @ 28V AC/DC; UL File No. E44145
CSA Certified: All solder lug models recognized at 3A @ 125/250V AC or
 0.4VA maximum @ 28V AC/DC maximum; CSA File No. LR23535

POLES & CIRCUITS

		Plunger Position () = Momentary		Connected Terminals		Throw & Power/Lamp Schematics
Pole	Model	Normal	Down	Normal	Down	
SP	YB15 YB16*	ON ON	(ON) ON	1-3	1-2	Notes: Switch is marked with NO, NC, COM, L+, and L-. Lamp circuit is isolated and requires external power source. SPDT
DP	YB25 YB26*	ON ON	(ON) ON	1-3 4-6	1-2 4-5	DPDT

* When in latched position for the alternate circuit, cap position is 0.5mm (.020") above the built-in bezel.

PANEL SEAL

No Code

Without Panel Seal

Bushing
Mounting

Supplied with
mounting nut.

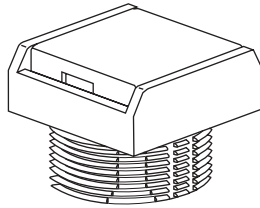

Snap-in
Mounting

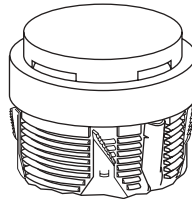

W

With Panel Seal

Bushing
Mounting
only

Supplied with
mounting nut
and o-ring.

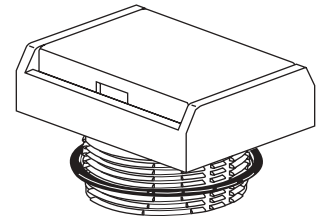

SHAPES & MOUNTING TYPES

Bushing Mounting

Snap-In Mounting

S Square

C Round

R Rectangular

K Square

M Round

N Rectangular

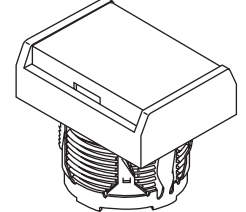
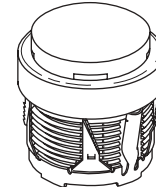
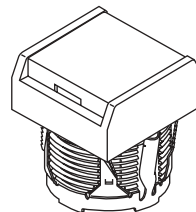
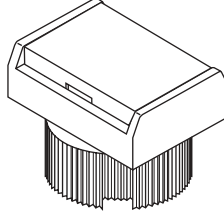
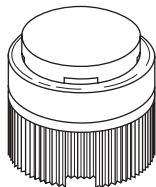
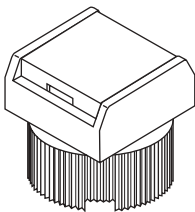

Bezel-barrier is an integral part of the switch body.

HOUSING

K Black

Housing available in black only. The 1-piece body and bezel-barrier have a matte finish.

CONTACT MATERIALS & RATINGS

W Silver Contacts

Power Level

3A @ 125/250V AC

G Gold Contacts

Logic Level

0.4VA @ 28V AC/DC

See Supplement Index (page Z1) for complete explanation of operating range.

TERMINALS

01 Solder Lug/ .110" Quick Connect

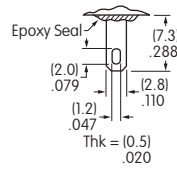

Wiring
The .047" x .079" oblong hole accommodates one solid 18-gauge wire or two solid or stranded 20-gauge wires.

03 Straight PC

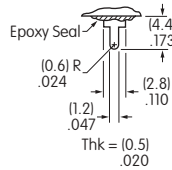

Single Pole

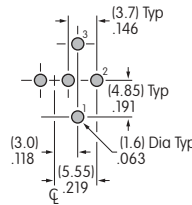

Double Pole

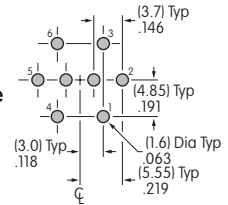

INCANDESCENT LAMP & SOLID CAP

Electrical Specifications

Electrical specifications are determined at a basic temperature of 25°C. Lamp circuit is independent of switch operation.

For dimension drawing of lamp see the Accessories & Hardware Index (page Y1).

If the source voltage is greater than rated voltage, a ballast resistor is required.

The ballast resistor calculation and more lamp detail are shown in the Supplement; see Supplement Index (page Z1).

AT611	Lamp Options				* Lamp life is significantly reduced in applications with DC current, high shock, vibration, flashing, or continuous illumination.
		05	12	28 *	
	Voltage	V	5V AC	12V AC	28V AC
	Current	I	115mA	60mA	22mA
	MSCP		.150	.150	.150
	Endurance	Hours	7,000 average		
	Ambient Temp Range		-25°C ~ +50°C		

T-1 Bi-pin

00 No Lamp Code 00 indicates that no lamp is used with the solid cap.

Solid Cap for Incandescent Lamp & Nonilluminated

Lens/Insert Colors Available:

BB White/White

CB Red/White

EB Yellow/White

FB Green/White

GB Blue/White

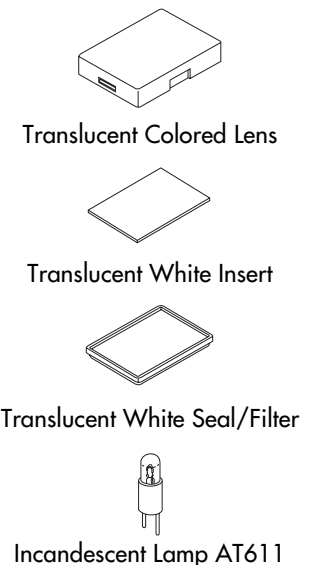
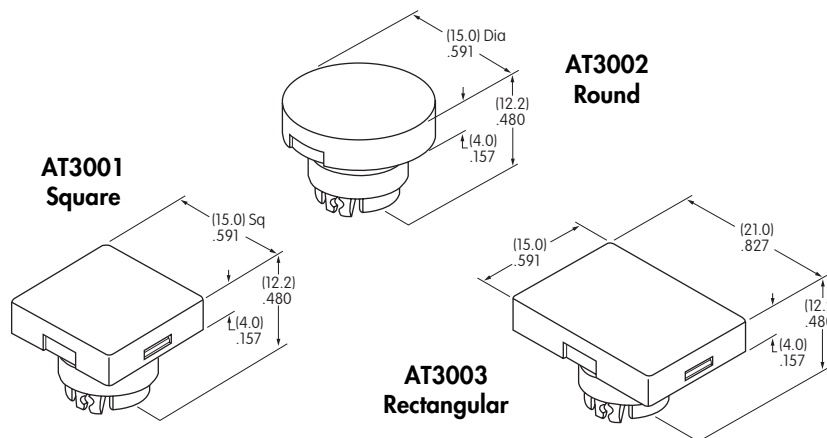

Materials: Polycarbonate (Lens & Insert)
Thermoplastic Elastomer (Seal/Filter)

SPOT ILLUMINATED CAP WITH BUILT-IN LED

This spot-illuminated cap is factory assembled.

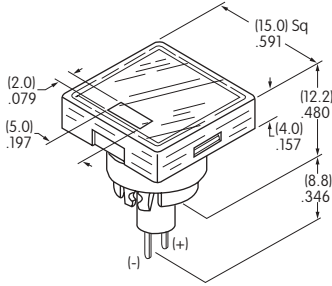

AT3010
Square

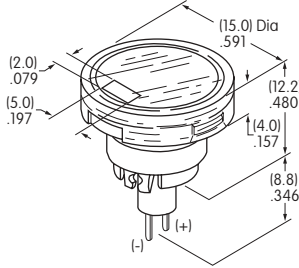

AT3011
Round

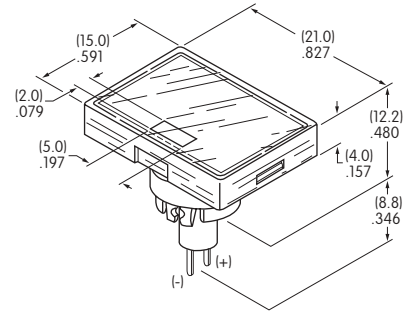

AT3012
Rectangular

Colors Available:	02	05	12	24
1C Red 1D Amber 1F Green 1CF Red/Green	w/o Resistor	w/Resistor	w/Resistor	w/Resistor
Forward Peak Current	I_{FM} 20mA	15mA	15mA	12mA
Continuous Forward Current	I_F 15mA	12.5mA	12.5mA	10mA
Forward Voltage	V_F 2.1V	5V	12V	24V
Reverse Peak Voltage (not applicable to bicolor)	V_{RM} 5V	5V	5V	5V
Current Reduction Rate Above 25°C	ΔI_F 0.27mA/°C	-----	-----	-----
Ambient Temperature Range	-25°C ~ +50°C			
Without Resistor 2-volt		With Resistor 5, 12, 24-volt		
Single Color	Bicolor	Single Color	Bicolor	
Electrical specifications are determined at a basic temperature of 25°C. Lamp circuit is independent of switch operation. Single color LEDs are colored in OFF state. Bicolor LED is translucent white in OFF state. If the source voltage is greater than rated voltage, a ballast resistor is required. The ballast resistor calculation and more lamp detail are shown in the Supplement; see Supplement Index (page Z1).				

Lens/Insert

Colors Available:

JA Clear/Black

JB Clear/White

JC Clear/Red

JE Clear/Yellow

JF Clear/Green



Clear Lens



Colored Insert



Seal

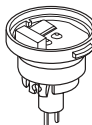

Built-in LED
(integral part
of the cap)

Example part number
when cap is ordered separate from switch:

AT3010F02JA

for a

Square Spot Illuminated Cap
with Green 2-volt LED without resistor
Clear Lens and Black Insert

Materials: Polycarbonate (Lens & Insert) and Thermoplastic Elastomer (Seal)

BRIGHT LED & LED CAPS

Electrical specifications are determined at a basic temperature of 25°C.

LED circuit is independent of switch operation.

If the source voltage is greater than rated voltage, a ballast resistor is required. The ballast resistor calculation is shown in the Supplement (see page Z1) & lamp drawings are in Accessories & Hardware (see page Y1).

Electrical Specifications for Bright LED

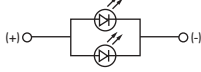
Bright AT628  T-1 Bi-pin		Colors:	5C Red	5D Amber	5F Green	
		Forward Peak Current	I_{FM}	40mA	40mA	40mA
		Continuous Forward Current	I_F	26mA	26mA	26mA
		Forward Voltage	V_F	1.9V	2.0V	2.2V
		Reverse Peak Voltage	V_{RM}	4V	4V	4V
		Current Reduction Rate Above 25°C	ΔI_F	0.50mA/°C		
		Ambient Temperature Range		-25°C ~ +50°C		

Cap for Bright LED

AT3004
Square

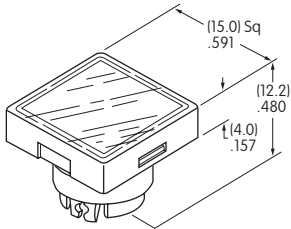

AT3005
Round

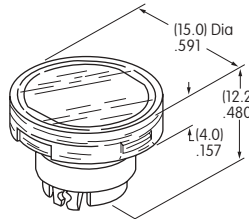

AT3006
Rectangular

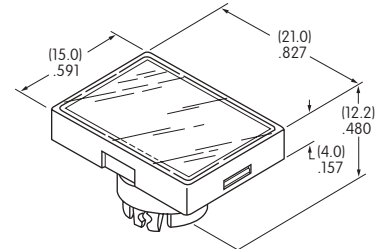

Lens/Insert
Color Codes:

JB Clear/White

JC Clear/Red

JD Clear/Amber

JF Clear/Green

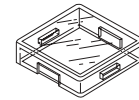

Transparent Clear Lens

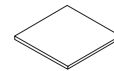

Translucent Colored Insert

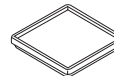

Translucent White Seal/Diffuser



Bright LED
AT628

Materials: Polycarbonate (Lens & Insert)
Thermoplastic Elastomer (Seal/Diffuser)



SUPER BRIGHT LED & LED CAPS

Electrical specifications are determined at a basic temperature of 25°C.

LED circuit is independent of switch operation.

If the source voltage is greater than rated voltage, a ballast resistor is required. The ballast resistor calculation is shown in the Supplement (see page Z1) & lamp drawings are in Accessories & Hardware (see page Y1).

Electrical Specifications for Super Bright LED

Super Bright AT625G Blue AT631B White AT632F Green			Colors:	6B	6F	6G		
				White	Green	Blue		
				Forward Peak Current	I_{FM}	30mA	30mA	30mA
				Continuous Forward Current	I_F	20mA	20mA	20mA
				Forward Voltage	V_F	3.6V	3.5V	3.6V
				Reverse Peak Voltage	V_{RM}	5V	5V	5V
				Current Reduction Rate Above 25°C	ΔI_F	0.50mA/°C		
Ambient Temperature Range				-25°C ~ +50°C				



T-1 Bi-pin

Cap for Super Bright LED

AT3014
Square

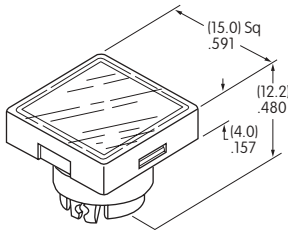

AT3015
Round

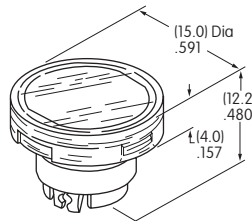

AT3016
Rectangular

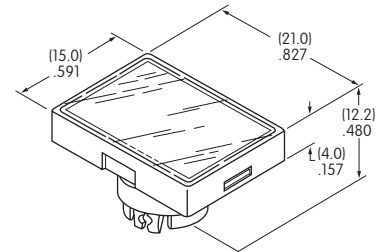

Lens/Insert
Colors Available:

JB Clear/White

Materials: Polycarbonate (Lens & Insert)
Thermoplastic Elastomer (Seal/Diffuser)



Super Bright LEDs
AT625 AT631
AT632

BICOLOR LED & LED CAPS

Electrical specifications are determined at a basic temperature of 25°C.

LED circuit is independent of switch operation.

If the source voltage is greater than rated voltage, a ballast resistor is required. The ballast resistor calculation and more lamp detail are shown in the Supplement; see Supplement Index (page Z1).

Electrical Specifications for Bicolor LED

Bicolor AT621 2CF Red/Green  T-1 1/2 Bi-pin	Bicolor LED is translucent white in OFF state.	02	05	12	24	
	Forward Peak Current	I_{FM}	60mA	60mA	20mA	12mA
	Continuous Forward Current	I_F	45mA	45mA	15mA	10mA
	Forward Voltage	V_F	2.1V	5V	12V	24V
	Current Reduction Rate Above 25°C	ΔI_F	0.80mA/°C	-----	-----	-----
	Ambient Temperature Range		-25°C ~ +50°C			

AT621 Bicolor LED with 6 Elements 2-volt w/o Resistor

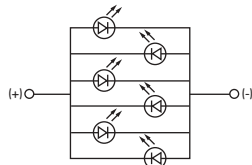

AT621 Bicolor LED with 6 Elements 5-volt with Resistor

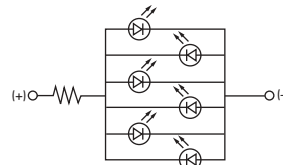

AT621 Bicolor LED with 6 Elements 12 & 24-volt with Resistor

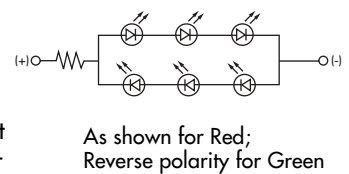

LED Caps

Square AT3004

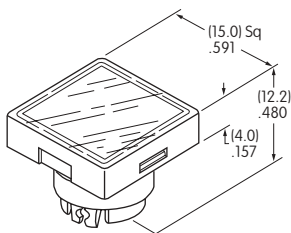

Round AT3005

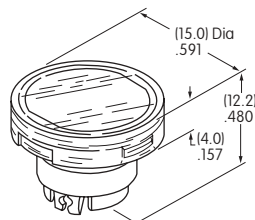

Rectangular AT3006

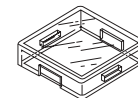
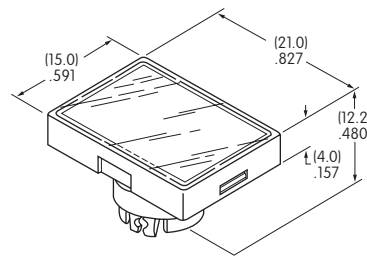

Transparent Clear Lens

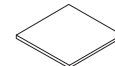

Transparent Colored Insert

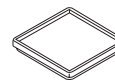

Translucent White Seal Diffuser

Lens/Insert Colors Available:

JB Clear/White

Materials: Polycarbonate (Lens & Insert)
Thermoplastic Elastomer (Seal/Diffuser)



Bicolor AT621

TYPICAL SWITCH DIMENSIONS

Square • Bushing Mounting

Single & Double Pole

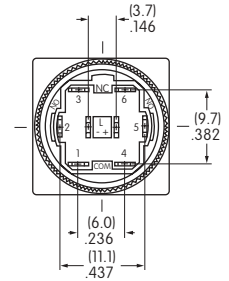
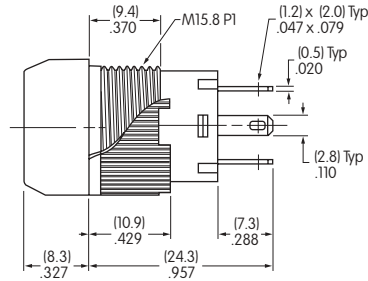
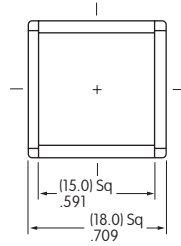

YB15SKW01-12-CB

Single pole models do not have terminals 4, 5, & 6.

Round • Panel Seal

Single & Double Pole

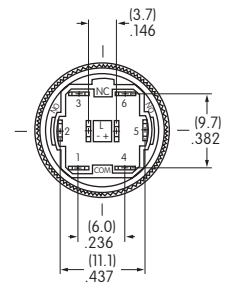
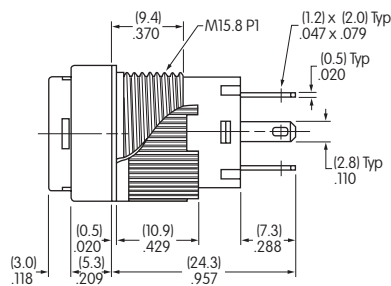
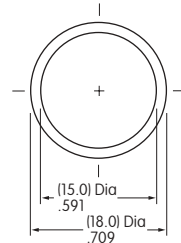

YB25WCKW01-12-EB

Single pole models do not have terminals 4, 5, & 6.

Rectangular • Snap-in Mounting

Single & Double Pole

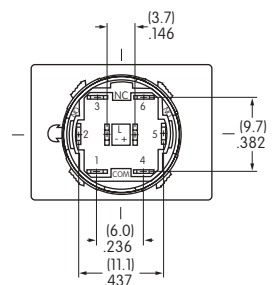
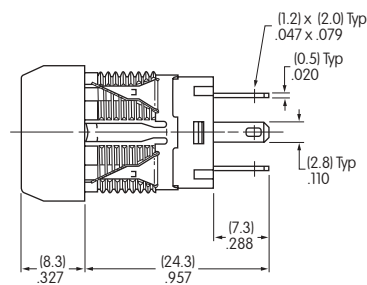
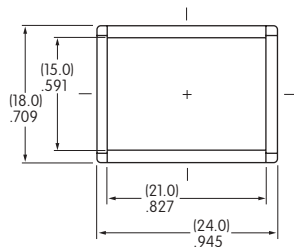

YB15NKW01-C04-JC

Single pole models do not have terminals 4, 5, & 6.

PANEL THICKNESS & CUTOUTS

Bushing & Panel Seal Mount

Panel Thickness
0.5mm ~ 5.0mm
(.020" ~ .197")

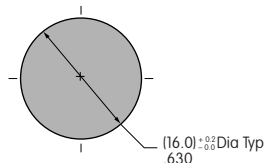

Snap-in Mount

Panel Thickness
1.0mm ~ 3.5mm
(.039" ~ .138")

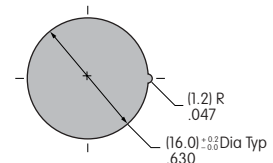

OPTIONAL ACCESSORIES

Panel thickness range with **Splash Cover or Protective Guard**: 0.5 ~ 3.8mm (.020 ~ .150") for Bushing Mounting
0.5 ~ 2.3mm (.020 ~ .091") for Snap-in Mounting

Splash Covers and Protective Guards reduce the depth of switch behind panel by .047mm.

Dust/Splash Cover

AT4115
Dust Cover
for Snap-in or Bushing Mount

AT4115 with AT541 O-ring
Splash Cover
for Bushing Mount

Materials:
Lid: Polyvinyl Chloride
Base: Polyamide
O-ring: Nitrile butadiene rubber

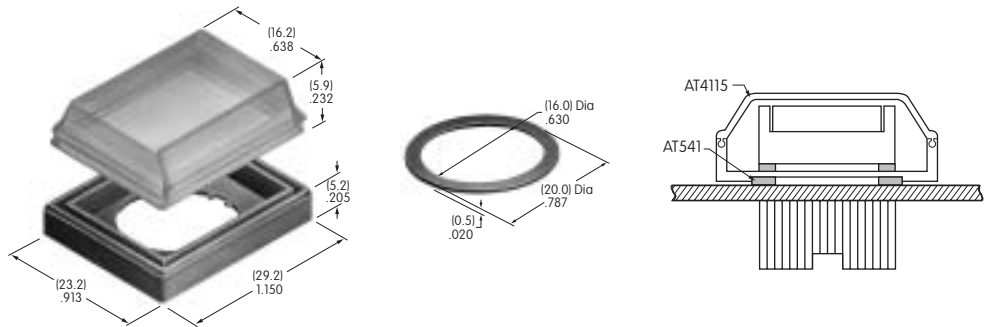

Protective Guard

AT4072
Protective Guard

Materials:
Lid: Polycarbonate
Base: Glass Fiber Reinforced Polycarbonate

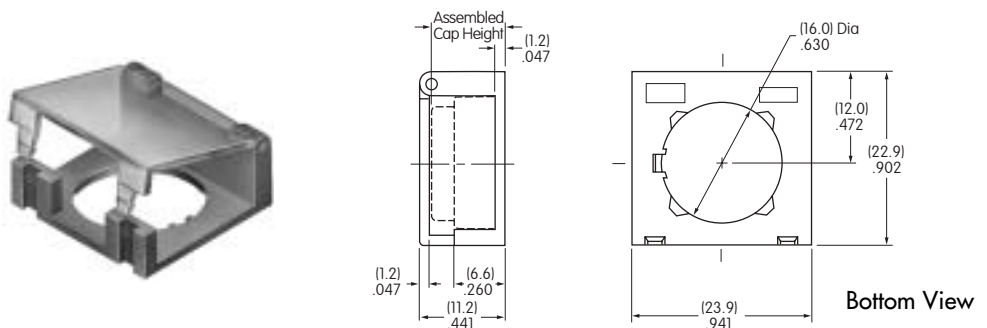

ASSEMBLY INSTRUCTIONS

Cap Assembly

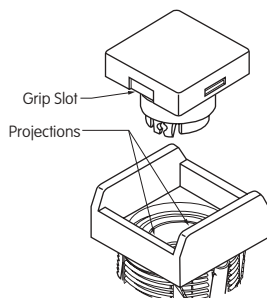

LED Polarity & Orientation in Lamp Socket

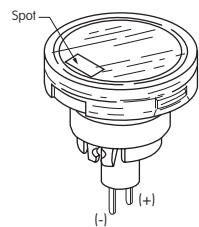
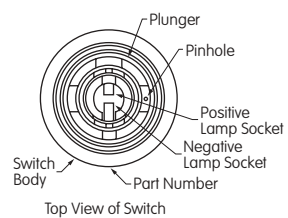

Spot Illuminated Cap with Built-in LED

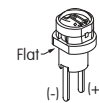

LED AT628

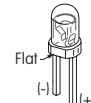

LEDs AT625 AT631 AT632

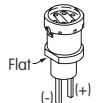

LED AT621

AT106 Socket Wrench
for Bushing Mounting



Overtightening the mounting nut may damage the switch housing.

AT109 Cap Extractor



AT111 Lamping Tool



LEGENDS

General information and basic specifications are presented here for customers who want to do their own legends.

Suggested Printable Area for Lens



Recommended Print Method:

Screen Print or Pad Print

Epoxy based ink is recommended.

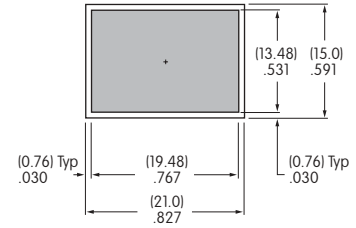
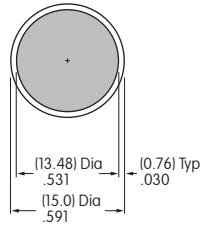
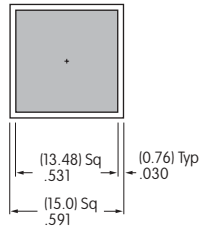

Shaded areas are printable areas.

Suggested Printable Area for Film Insert

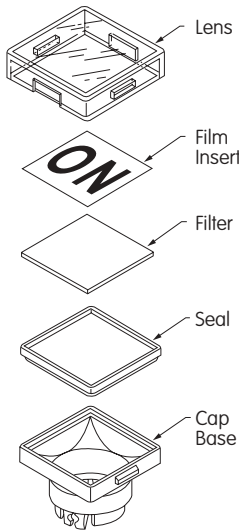

Film Material and Thickness:

Clear Polyester, 4 mil max.

Recommended Print Method:

Screen Print

Epoxy based ink is recommended.

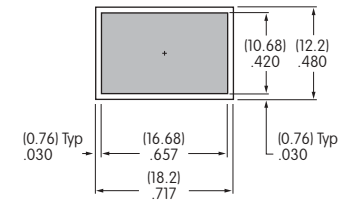
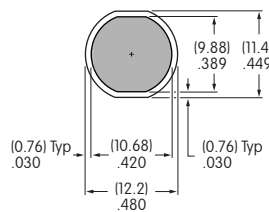
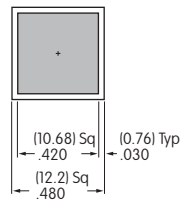

Shaded areas are printable areas.

Additional Methods

Additional methods for legends are engraving the lens and laser printing on film inserts. Maximum depth for engraving is 0.3 mm (.012") on the cap lens. Enamel paint is recommended to fill the engraved area.

LEGEND PACKET FOR ORDERING CAPS WITH LEGENDS

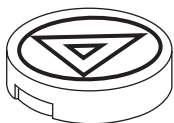

1. To order caps with legends contact the factory and request the YB Legend Packet.
2. Once you determine your desired legend, fill out the ordering work sheet included in the packet.
3. Return the completed work sheet to receive a quotation.