

# multimec® 3F + 1K + 2K

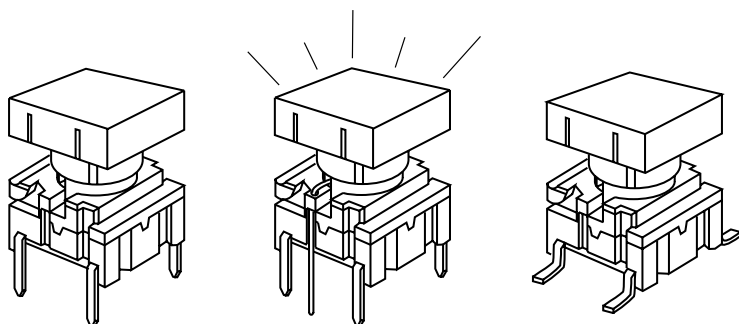

## Technical Data:

- through-hole or SMD
- 50mA/24VDC
- single pole/momentary
- 10.000.000 operations life time
- IP67 sealing
- temperature range:  
low temp: -40/+115°C  
high temp: -40/+160°C

## Dimensions (through-hole)

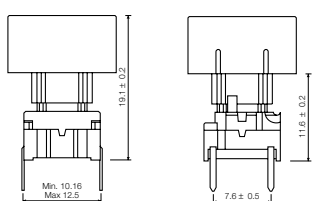

### PCB layout

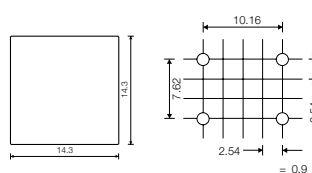

## Dimensions (w/LED)

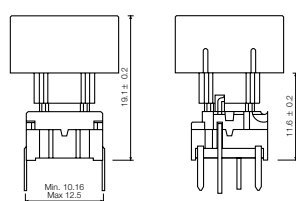

### PCB layout (solder side)

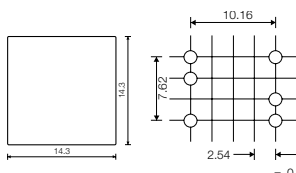

## Dimensions (SMD)

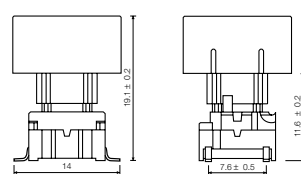

### PCB layout

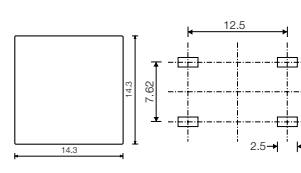

## Dimensions (Bezel) (Optional)

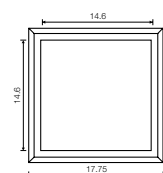
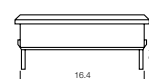

## HOW TO ORDER

**3 F**

**Switch**



**Mounting**

**T** through-hole  
**S** surface mount



**L 6** low temp.  
**H 9** high temp.

+

**1 K 1 1 6**

**Cap**

**00** blue  
**02** green  
**03** grey  
**04** yellow  
**06** white  
**08** red  
**09** black



+

**2 K**

**Bezel**

**03** grey  
**06** white  
**08** red  
**09** black



### Standard versions:

3FTL6  
3FTH9  
3FSH9

**3 F**

**Switch**



**Mounting**

**T** through-hole



**L 6** low temp.  
**H 9** high temp.

+

**1 K 1 1 1 6**

**Cap**

transparent



+

**2 K**

**Bezel**

**03** grey  
**06** white  
**08** red  
**09** black



### Standard versions:

3FTL622  
3FTL644  
3FTL688

**Ordering example:** 3FTL688 + 1K1116